

KISTOCK DATALOGGERS KP 320 / KP 321

Differential pressure

KEY POINTS

- Software for configuration and data visualisation freely downloadable
- Software for configuration and data processing available in option
- Safety lock wall mount with inviolability system
- Storage capacity of 2 000 000 points
- Fast data downloading: 18 000 points/s
- 2 configurable setpoint alarms for each channel
- 2 lines LCD screen
- Bluetooth® communication for smartphones and tablets (Android and IOS)
- Magnetic mounting
- IP 65 protection*



REFERENCES

Device reference	Display	Internal sensor		External sensor		Parameters	Number of record points
		Number	Type	Number	Type		
KP 320 KP 321	Yes	1	Differential pressure	-		Differential pressure	2 000 000

HOUSING

Dimensions

110.2 x 79 x 35.4 mm

Weight

206 g

Display

2 lines LCD screen

Dimensions of screen: 49.5 x 45 mm

2 indication LEDs (red and green)

Control

1 OK key

1 Selection key

Material

Compatible with food industry environment

ABS housing

Battery power supply

2 lithium double AA 3.6 V batteries

Protection

IP 65*

PC communication

1 micro-USB input

Environmental conditions of use

Air and neutral gases

Hygrometry: in non-condensing conditions

Maximum altitude: 2000 m

* With the pressure connectors plugged.

TECHNICAL FEATURES

	KP 320	KP 321
Units displayed	Pa	Pa
Measuring range	±1000 Pa	±10 000 Pa
Resolution	1 Pa	1 Pa
Accuracies*	±0.5% of the reading ±3 Pa	±0.5% of the reading ±30 Pa
Tolerated overpressure	21 000 Pa	69 000 Pa
External input	Micro-USB female connector	
Input for probe	2 pressure connections	
Internal sensor	Differential pressure	
Setpoints alarm	2 setpoint alarms on each channel	
Frequency of measurements	From 1 second to 24 hours	
Operating temperature	From 5 to +50°C	
Storage temperature	From -40 to 85°C	
Battery life	7 years **	
European directives	2011/65EU RoHS II; 2012/19/EU WEEE; 2014/30/EU EMC; 2014/35/EU	

* All accuracies indicated in this document were stated in laboratory conditions and can be guaranteed for measurement carried out in the same conditions, or carried out with calibration compensation.

** On the basis of 1 measurement each 15 minutes at 25°C.

RECORDER FUNCTIONS

5 recording modes

KISTOCK can record in 5 different ways :

- **"Immediate"** mode records values according to a predefined interval.
- **"Minimum"**, **"Maximum"** and **"Average"** record automatically the calculation of minimum, maximum or average of measured values during an interval of recording.
- **"Monitoring"** mode allows to get an accurate history report during error events to help troubleshooting, without stopping the measurement logging. To proceed this way, you just have to define :
 - a record interval to be used whilst the readings are beyond the setpoints.
 - a record interval for the values measured during each reading beyond the setpoints.
 Furthermore, you can also let your KISTOCK record non-stop (**"loop"** recording option).

4 types of dataset start

Once your recording mode has been set, you can launch your dataset :

- With a delayed start (with predefined date and time)
- With the software
- With push-button
- With **"Online"** option. In this case, your datasets are directly sent, saved and displayed on your PC in real time.

6 types of dataset stop

You can stop your dataset :

- According to a date and time (if it was started the same way)
- According to a period
- According to a predefined number of recording points
- Once the storage capacity is full
- With **"Stop"** option of the software
- By holding **"OK"** key during 5 seconds, if this function has been previously activated by the software

DIMENSIONS (mm)

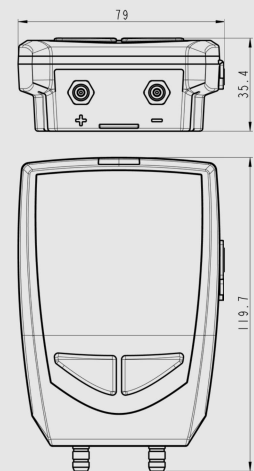

CONNECTIONS

Two pressure connections





PC CONNECTION

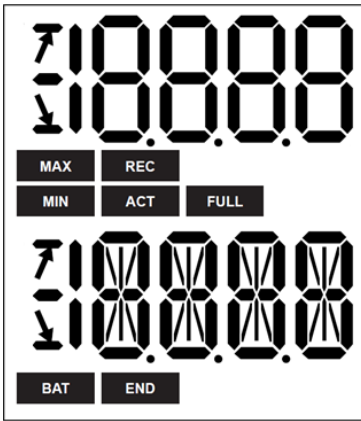

DISPLAY



- END** DATASET is finished.
- REC** Indicates that one value is being recorded.
It flashes: the DATASET did not start already.
- FULL** Flashing slowly: DATASET is between 80 and 90 % of the storage capacity.
Flashing quickly: DATASET is between 90 and 100 % of the storage capacity.
Constant: storage capacity full.
- BAT** Constant: indicates that the batteries have to be replaced.
- ACT** Screen actualisation of measured values.
- MIN**
MAX The displayed values are the maximum/minimum values recorded for the channels displayed.
-  Indicates the alarm action type: rising or falling action.
- 

SOFTWARE



- **KILOG LITE:** free software to download on the KIMO website (kimo.fr). Allows the data download (graphics and points statement) and the datalogger configuration.



- **Configuration and data processing software**
KILOG software allows to configure, save and process your data in a very simple way.
- Software only: Ref. KILOG-3-N
- Complete set: software + 1 USB cable, Ref. KIC-3-N

SAFETY LOCK WALL MOUNT WITH PADLOCK



The system allows to secure your KISTOCK datalogger on sensitive sites.



➤ Mount the safety lock support on the required place.

1. Present the KISTOCK datalogger on the support **starting with the inferior part**
2. Clip the KISTOCK on the support by falling back the superior part
3. Insert the padlock to ensure the safety lock function



The padlock can be replaced by a fail-safe sealed



The datalogger can be placed on the screw-mount without the safety lock function

➤ To remove the datalogger from the support, proceed on reverse order.

MOUNTING

The KISTOCK class 320 has a magnetic mounting, so you can fix it easily.



DIMENSIONS OF THE WALL MOUNT (in mm)



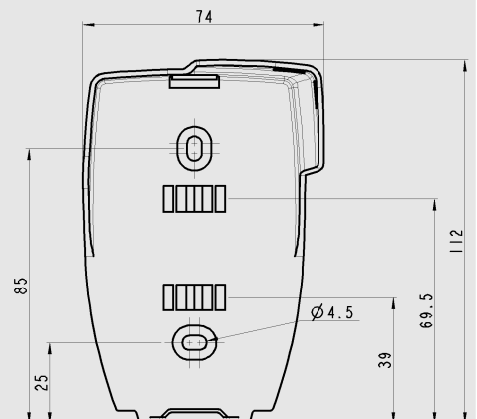

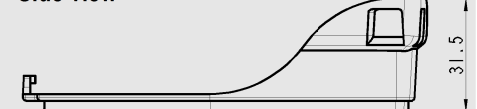

Front view



Side view



ACCESSORIES

Accessories	Part numbers	Illustrations
1 AA lithium 3.6 V battery ( 2 batteries are required for class 320 dataloggers)	KBL-AA	
Safety lock wall mount with padlock	KAV-320	
Wired extension for class 320 KISTOCK probes In polyurethane, 5 m length with male and female mini-DIN connectors <u>Note:</u> several extensions can be wired in order to obtain up to 25 m cable length	KRB-320	
Data collector Collects up to 20 000 000 points from one or several KISTOCK directly on-site. Results restitution on PC of realised datasets	KNT-320	
USB micro-USB cable which allows to plug your KISTOCK datalogger to your PC	CK-50	
Neck size hand strap	KDC	



Only the accessories supplied with the device must be used.

CALIBRATION

A calibration certificate is available as option in paper format.
We recommend to carry out a yearly checking.

MAINTENANCE

Please avoid any aggressive solvent.
Please protect the device and probes from any cleaning produce containing formalin, that may be used for cleaning rooms and ducts.

GUARANTEE PERIOD

KISTOCK dataloggers have 1-year guarantee for any manufacturing defect (return to our After-sales service required).

PRECAUTIONS FOR USE

Please always use the device in accordance with its intended use and within parameters described in the technical features in order not to compromise the protection ensured by the device.

REPLACE THE BATTERIES

With 7 years* of battery life, the KISTOCK devices guarantee long-term measurements.

To replace the batteries:

- > Unscrew the screw on the back side of the KISTOCK, on the battery hatch, with a cross-headed screwdriver.
- > Remove the hatch and the old batteries.
- > Insert the new batteries and respect the polarity.
- > Replace the battery hatch and screw it.

* On the basis of 1 measurement each 15 minutes at 25°C.



BE CAREFUL! Material damages can happen, so please apply the precautionary measures indicated.

 Once returned to KIMO, required waste collection will be assured in the respect of the environment in accordance to guidelines relating to WEEE.

www.kimo.fr

Distributed by :



EXPORT DEPARTMENT

Tel : + 33. 1. 60. 06. 69. 25 - Fax : + 33. 1. 60. 06. 69. 29

e-mail : export@kimo.fr